

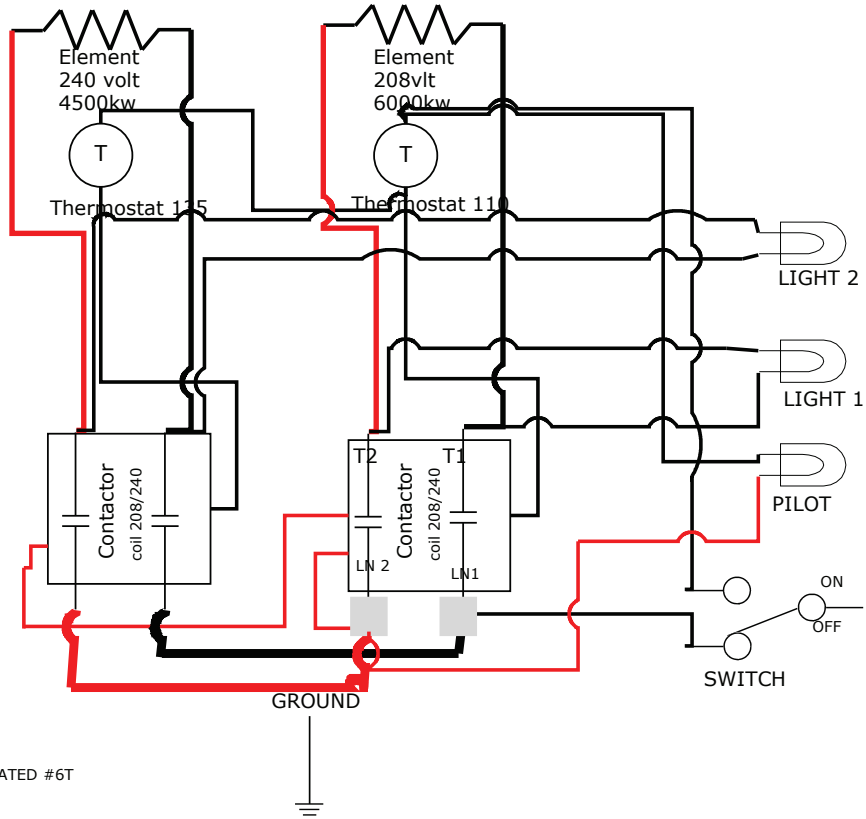

H-12-2

ELECTRIC DIAGRAM H-12-2



SINGLE LUG-AL DUAL RATED #6T

WIRE #16AWG

WIRE # 10AWG

WIRE # 8AWG

**NOTE: MODEL H-12-2
USE 50 AMP BREAKER AND 90°C COPPER WIRE W/GROUND**